



DAIKIN ROOM AIR CONDITIONER

# OPERATION MANUAL

English

Français

Español



Enjoy year-round comfort.

## MODELS

FTXV15AVJU9

FTXV18AVJU9

FTXV24AVJU9

# Features

## Enhanced comfort and energy savings



### COMFORT AIRFLOW

The airflow direction is upward while in COOL operation, and downward while in HEAT operation. This function prevents cold or warm air from blowing directly on your body. ▶Page 14



### ECONO



This function enables efficient operation by limiting the maximum power consumption. It is useful when using the air conditioner and other electrical devices simultaneously on a shared electrical circuit. ▶Page 15

# Contents



## ■ Read Before Operation

Safety Considerations .....	3
Names of Parts .....	5
Preparation Before Operation .....	9

## ■ Basic Operation

 AUTO · COOL · DRY · HEAT · FAN ONLY Operation .....	10
 Adjusting the Airflow Rate .....	12
 Adjusting the Airflow Direction .....	13

## ■ Useful Functions

 COMFORT AIRFLOW Operation .....	14
 POWERFUL Operation .....	14
 ECONO Operation .....	15

## ■ TIMER Operation

 ON/OFF TIMER Operation .....	16
--	----

## ■ Multi Connection

Note for Multi System .....	18
-----------------------------	----

## ■ Mobile Controller

 Wireless LAN connection .....	20
---	----

## ■ Making Changes to Default Settings

Brightness of Indoor Unit LED Lamps .....	23
Airflow Setting When Indoor Unit Reaches Setpoint .....	24

## ■ Care



Care and Cleaning .....	25
-------------------------	----

## ■ When the Need Arises

FAQ .....	29
Troubleshooting .....	30

# Safety Considerations

Refer also to the General Safety Considerations in the separate booklet.

	<p>Read the precautions in this manual carefully before operating the unit.</p>
	<p>This appliance is filled with R32.</p>

Read these **Safety Considerations for Operations** carefully before operating an air conditioner or heat pump.

Make sure that the unit operates properly during the startup operation. Instruct the user on how to operate and maintain the unit. Inform users that they should store this operation manual with the installation manual for future reference.

Meanings of **DANGER**, **WARNING**, **CAUTION**, and **NOTE** Symbols:

 **DANGER** ..... Indicates an imminently hazardous situation which, if not avoided, will result in death or serious injury.

 **WARNING** ..... Indicates a potentially hazardous situation which, if not avoided, could result in death or serious injury.

 **CAUTION** ..... Indicates a potentially hazardous situation which, if not avoided, may result in minor or moderate injury. It may also be used to alert against unsafe practices.

 **NOTE** ..... Indicates situations that may result in equipment or property-damage accidents only.

## **DANGER**

- Do not install the unit in an area where flammable materials are present due to risk of explosion resulting in serious injury or death.
- Any abnormalities in the operation of the air conditioner or heat pump, such as smoke or fire, could result in severe injury or death. Turn off the power and contact your dealer immediately.
- Refrigerant gas may produce toxic gas if it comes into contact with fire, such as from a fan heater, stove, or cooking device. Exposure to this gas could cause severe injury or death.
- For refrigerant leakage, consult your dealer. Refrigerant gas is heavier than air and replaces oxygen. A massive leak could lead to oxygen depletion, especially in basements, and an asphyxiation hazard could occur leading to serious injury or death.
- If equipment utilizing a burner is used in the same room as the air conditioner or heat pump, there is the danger of oxygen deficiency which could lead to an asphyxiation hazard resulting in serious injury or death. Be sure to ventilate the room sufficiently to avoid this hazard.
- Safely dispose of the packing materials. Packing materials, such as nails and other metal or wooden parts, may cause stabs or other injuries.

- Tear apart and throw away plastic packaging bags so that children will not play with them. Children playing with plastic bags face the danger of death by suffocation.

## **WARNING**

- Contact your dealer for repair and maintenance. Improper repair and maintenance may result in water leakage, electric shock, and fire. Only use accessories made by Daikin that are specifically designed for use with the equipment and have them installed by a professional.
- Contact your dealer to move and reinstall the air conditioner or heat pump. Incomplete installation may result in water leakage, electric shock, and fire.
- Never let the indoor unit or the remote controller get wet. Water can cause an electric shock or a fire.
- Never use flammable spray such as hair spray, lacquer, or paint near the unit. Flammable spray may cause a fire.
- When a fuse blows out, never replace it with one of incorrect ampere ratings or different wires. Always replace any blown fuse with a fuse of the same specification.
- Never remove the fan guard of the unit. A fan rotating at high speed without the fan guard is very dangerous.
- Never inspect or service the unit by yourself. Contact a qualified service person to perform this work.
- Turn off all electrical power before doing any maintenance to avoid the risk of serious electric shock; never sprinkle or spill water or liquids on the unit.
- Do not touch the switch with wet fingers. Touching a switch with wet fingers can cause electric shock.
- Do not allow children to play on or around the unit to prevent injury.
- The heat exchanger fins are sharp enough to cut. To avoid injury wear gloves or cover the fins while working around them.
- Do not put a finger or other objects into the air inlet or air outlet. The fan is rotating at high speed and will cause injury.
- Check the unit foundation for damage on a continuous basis, especially if it has been in use for a long time. If left in a damaged condition the unit may fall and cause injury.
- Placing a flower vase or other containers with water or other liquids on the unit could cause a shock or fire if a spill occurs.
- Do not touch the air outlet or horizontal blades while the swing flap is in operation because fingers could get caught and injured.
- Never touch the internal parts of the controller. Do not remove the front panel because some parts inside are dangerous to touch. To check and adjust internal parts, contact your dealer.
- Do not use means to accelerate the defrosting process or to clean, other than those recommended by the manufacturer.
- The appliance must be stored in a room without continuously operating ignition sources (for example: open flames, an operating gas appliance or an operating electric heater).
- Do not pierce or burn.
- Be aware that refrigerants may not contain an odor.

**⚠ CAUTION**

- Do not use the air conditioner or heat pump for any other purposes other than comfort cooling or heating. Do not use the unit for cooling precision instruments, food, plants, animals or works of art.
- Do not place items under the indoor unit as they may be damaged by condensates that may form if the humidity is above 80% or if the drain outlet gets blocked.
- Before cleaning, stop the operation of the unit by turning the power off or by pulling the supply cord out from its receptacle. Otherwise, an electric shock and injury may result.
- Do not wash the air conditioner or heat pump with excessive water. An electric shock or fire may result.
- Avoid placing the controller in a spot which may be splashed with water. Water entering the controller may cause an electric shock or damage the internal electronic parts.
- Do not operate the air conditioner or heat pump when using a room-fumigation type of insecticide. Failure to observe this could cause the chemicals to be deposited in the unit and can endanger the health of those who are hypersensitive to chemicals.
- Do not turn off the power immediately after stopping operation. Always wait for at least 5 minutes before turning off the power. Otherwise, water leakage may occur.
- The appliance is not intended for use by young children or infirm persons without supervision.
- The remote controller should be kept away from children so they cannot play with it.
- Consult with the installation contractor for cleaning.
- Incorrect cleaning of the inside of the air conditioner or heat pump could make the plastics parts break and cause water leakage or electric shock.
- Do not touch the air inlet or aluminum fin of the air conditioner or heat pump as they can cut and cause injury.
- Do not place objects in direct proximity of the outdoor unit. Do not let leaves and other debris accumulate around the unit. Leaves are a hotbed for small animals which can enter the unit. Once inside the unit, animals can cause the unit to malfunction, and cause smoke or fire when they make contact with electrical parts.
- Do not wipe the controller operation panel with benzene, thinner, chemical dust cloth, etc. The panel may get discolored or the coating can peel off. If it is heavily dirty, soak a cloth in water-diluted neutral detergent, squeeze it well and wipe the panel clean. Then wipe it with another dry cloth.
- Dismantling of the unit, disposal of the refrigerant, oil, and additional parts, should be done in accordance with the relevant local, state, and national regulations.
- Operate the air conditioner or heat pump in a sufficiently ventilated area and not surrounded by obstacles. Do not use the air conditioner or heat pump in the following places.
  - a. Places with a mist of mineral oil, such as cutting oil.
  - b. Locations such as coastal areas where there is a lot of salt in the air.
  - c. Locations such as hot springs where there is a lot of sulfur in the air.
  - d. Locations such as factories where the power voltage varies a lot.
  - e. In cars, boats, and other vehicles.
  - f. Locations such as kitchens where oil may splatter or where there is steam in the air.
  - g. Locations where equipment produces electromagnetic waves.
  - h. Places with an acid or alkaline mist.
  - i. Places where fallen leaves can accumulate or where weeds can grow.
- Take snow protection measures. Contact your dealer for the details of snow protection measures, such as the use of a snow protection hood.
- Do not attempt to do electrical work or grounding work unless you are licensed to do so. Consult with your dealer for electrical work and grounding work.
- Pay attention to operating sound. Be sure to use the following places:
  - a. Places that can sufficiently withstand the weight of the air conditioner or heat pump yet can suppress the operating sound and vibration.
  - b. Places where warm air from the air outlet of the outdoor unit or the operating sound of the outdoor unit does not annoy neighbors.
- Make sure that there are no obstacles close to the outdoor unit. Obstacles close to the outdoor unit may drop the performance of the outdoor unit or increase the operating sound of the outdoor unit.
- Consult your dealer if the air conditioner or heat pump in operation generates unusual noise.
- Make sure that the drainpipe is installed properly to drain water. If no water is discharged from the drainpipe while the air conditioner or heat pump is in the cooling mode, the drainpipe may be clogged with dust or dirt and water leakage from the indoor unit may occur. Stop operating the air conditioner or heat pump and contact your dealer.
- Do not spray the air conditioner unit with any deodorizers, etc. It may cause the unit to malfunction.

**⚠ NOTE**

- Never press the button of the remote controller with a hard, pointed object. The remote controller may be damaged.
- Never pull or twist the electric wire of the remote controller. It may cause the unit to malfunction.
- Do not place appliances that produce open flames in places that are exposed to the airflow of the unit or under the indoor unit. It may cause incomplete combustion or deformation of the unit due to the heat.
- Do not expose the controller to direct sunlight. The LCD display can become discolored and may fail to display the data.

FTP002(R32)-U

# Names of Parts

## Indoor Unit

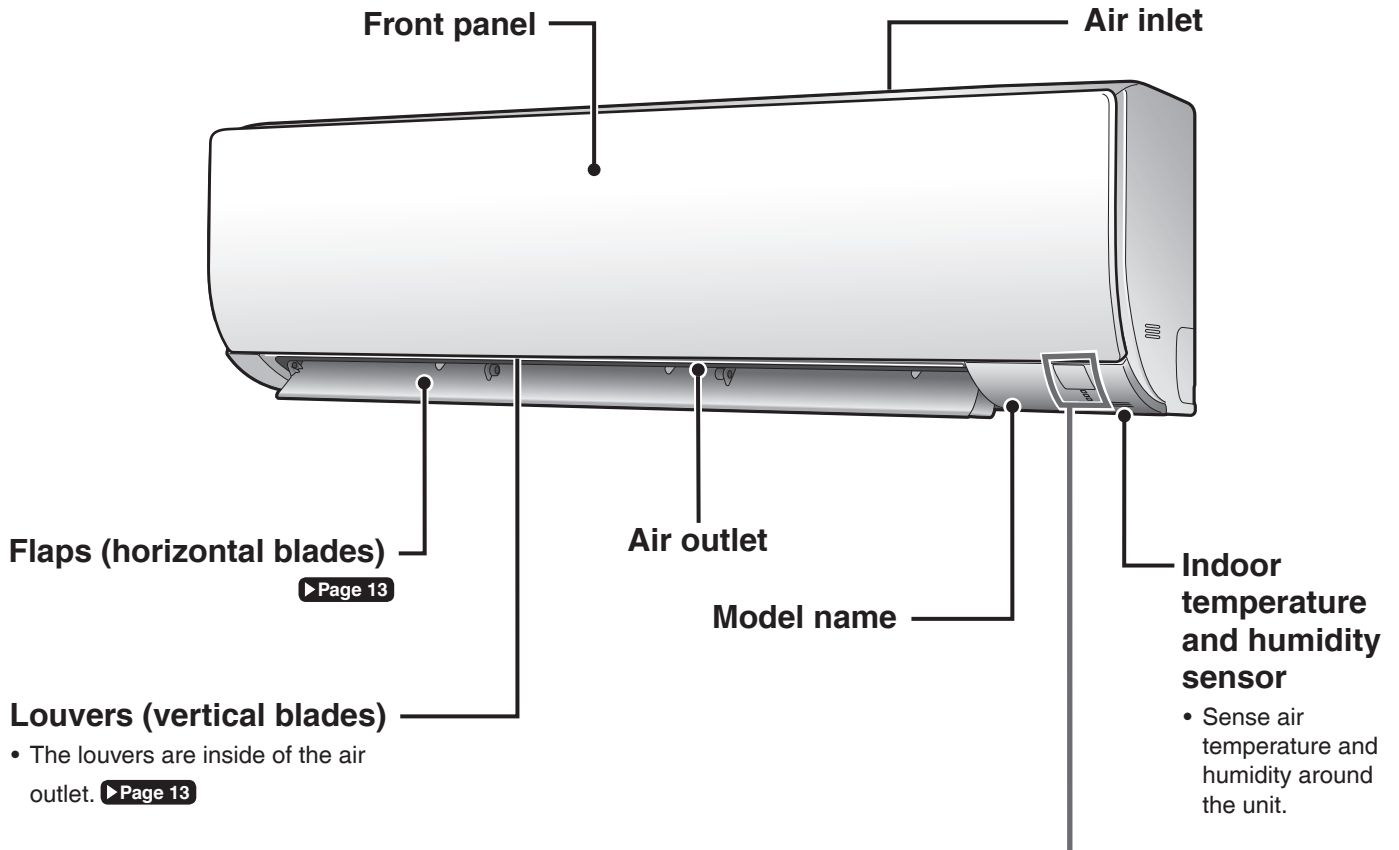

## Display

### Signal receiver

- Receives signals from the remote controller.
- When the unit receives a signal, you will hear a beep sound.

Case	Sound type
Operation start	beep-beep
Setting changed	beep
Operation stop	long beep

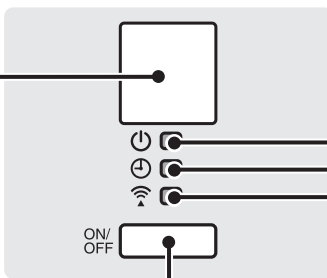

**OPERATION lamp (Green)**  
▶ Page 10

**TIMER lamp (Orange)**  
▶ Page 16, 17

**Wireless LAN connection adapter lamp (Orange)**  
▶ Page 8, 21, 22

### Indoor unit ON/OFF switch

- Press this switch once to start operation. Press once again to stop it.
- For the operation mode setting, refer to the following table.

Mode	Temperature setting	Airflow rate
AUTO	77°F (25°C)	AUTO

- This switch can be used when the remote controller is missing or out of batteries.

### ■ Open the front panel

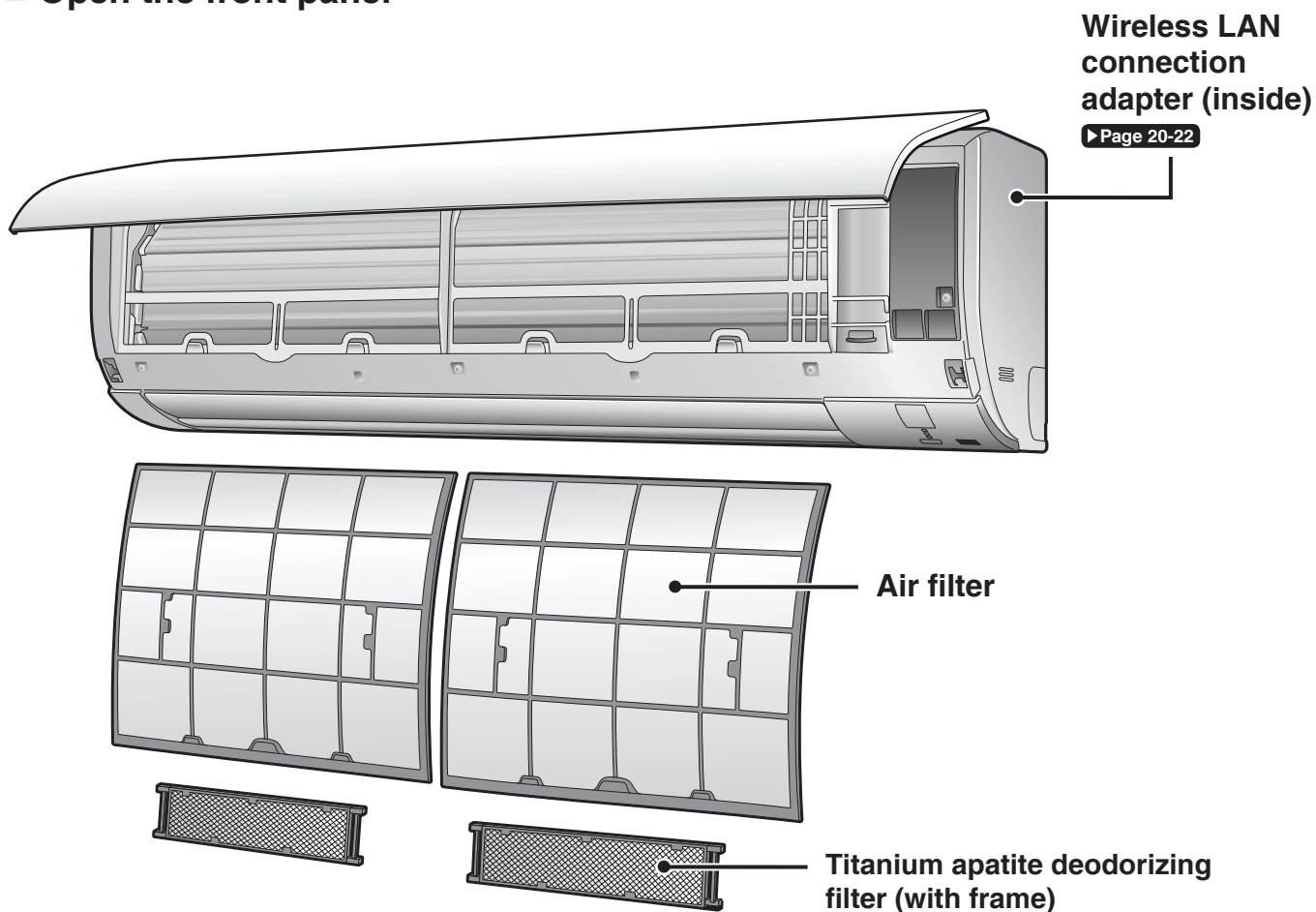

### Outdoor Unit

• The appearance of the outdoor unit may differ between different models.

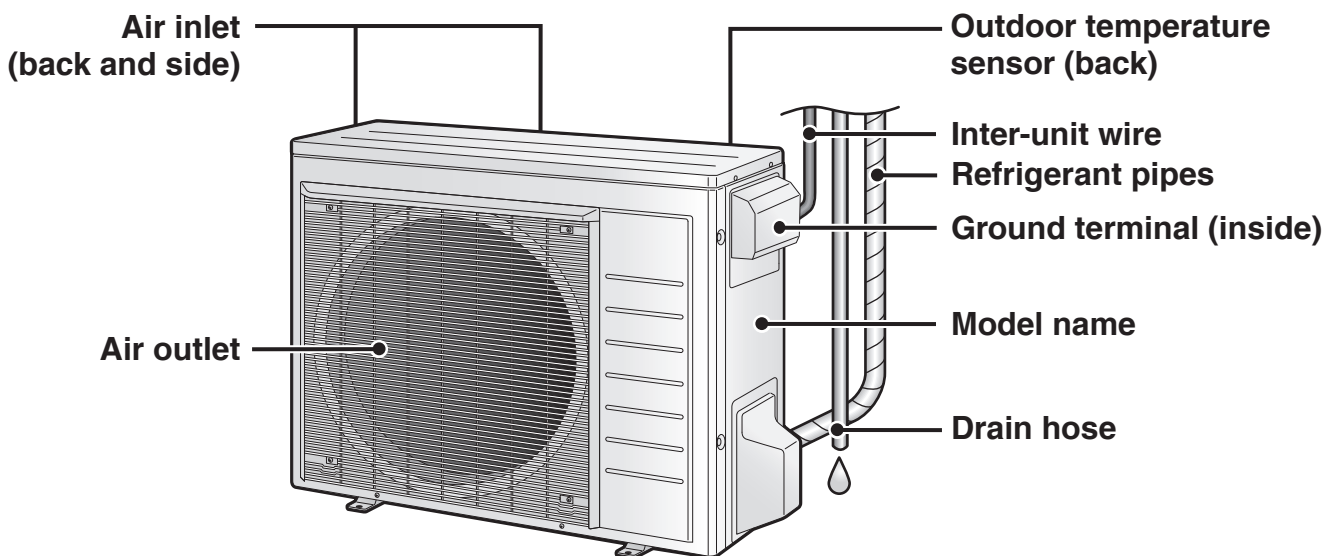

# Names of Parts

## Remote Controller

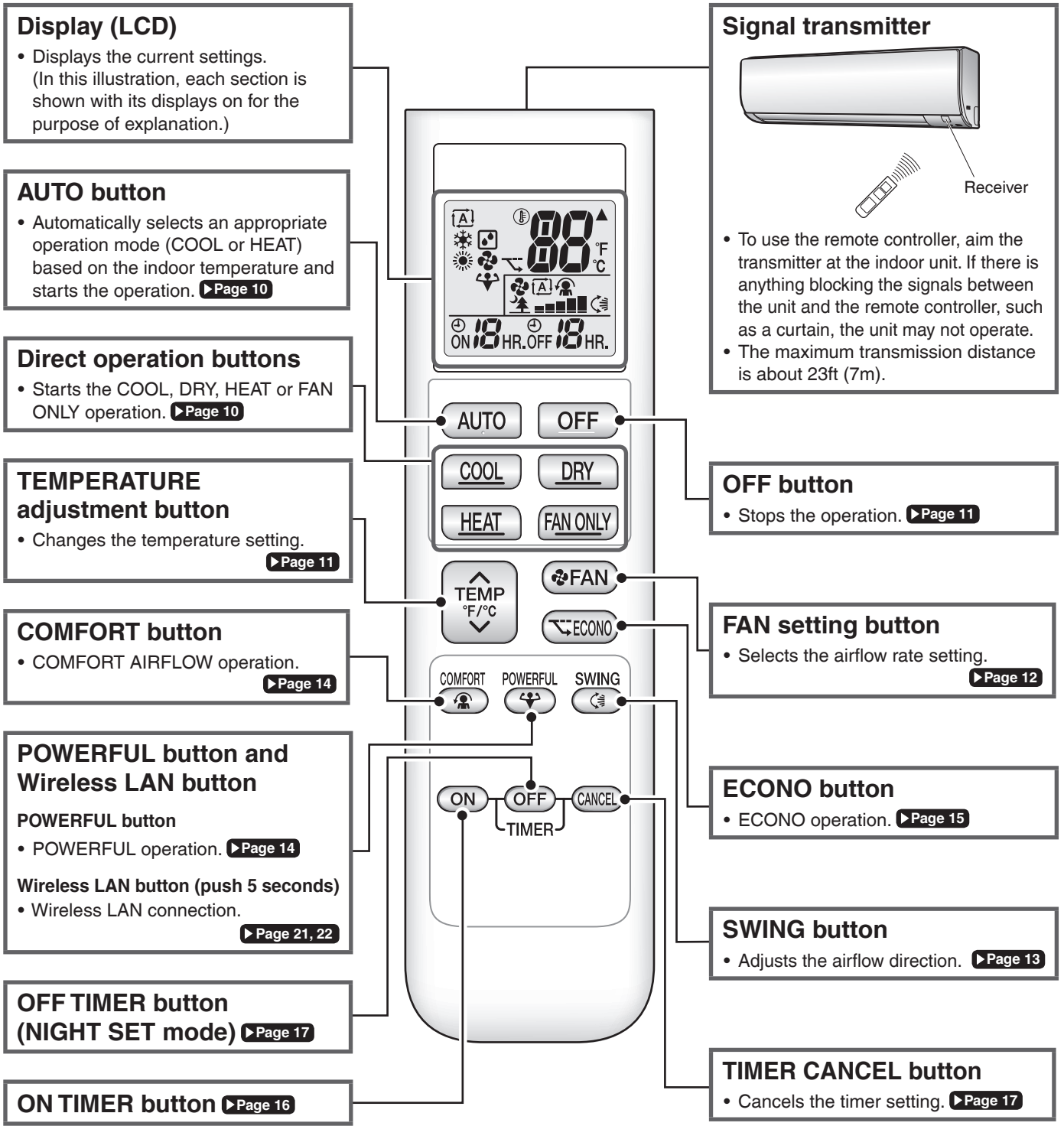

**Display (LCD)**

- Displays the current settings. (In this illustration, each section is shown with its displays on for the purpose of explanation.)

**AUTO button**

- Automatically selects an appropriate operation mode (COOL or HEAT) based on the indoor temperature and starts the operation. ▶Page 10

**Direct operation buttons**

- Starts the COOL, DRY, HEAT or FAN ONLY operation. ▶Page 10

**TEMPERATURE adjustment button**

- Changes the temperature setting. ▶Page 11

**COMFORT button**

- COMFORT AIRFLOW operation. ▶Page 14

**POWERFUL button and Wireless LAN button**

**POWERFUL button**

- POWERFUL operation. ▶Page 14

**Wireless LAN button (push 5 seconds)**

- Wireless LAN connection. ▶Page 21, 22

**OFF TIMER button (NIGHT SET mode)** ▶Page 17

**ON TIMER button** ▶Page 16

**Signal transmitter**

- To use the remote controller, aim the transmitter at the indoor unit. If there is anything blocking the signals between the unit and the remote controller, such as a curtain, the unit may not operate.
- The maximum transmission distance is about 23ft (7m).

**OFF button**

- Stops the operation. ▶Page 11

**FAN setting button**

- Selects the airflow rate setting. ▶Page 12

**ECONO button**

- ECONO operation. ▶Page 15

**SWING button**

- Adjusts the airflow direction. ▶Page 13

**TIMER CANCEL button**

- Cancels the timer setting. ▶Page 17

Model	ARC480A83
-------	-----------

## Wireless LAN connection adapter

The Wireless LAN connection adapter function requires the Daikin One Home for connecting to the air conditioner and controlling it via your smartphone or tablet over your network.

### Attention

- **Wireless LAN sends and receives data using radio waves so there is a risk of transmitted data being subject to eavesdropping and illegal access. When using wireless LAN, manage the SSID/KEY of the wireless LAN connection adapter, the SSID/KEY of the wireless router, and the app login information so that they will not be known to others, and ensure that you have an adequate understanding of the risks involved.** ▶ Page 6  
**In the case that the product is accessed and operated illegally, turn off the wireless LAN connection adapter function.** ▶ Page 22
- **Do not use this product near a microwave oven. (This can affect wireless LAN communications.)**
- **This product cannot be directly connected to the communication line of a telecommunications carrier (internet service provider, etc.). When connecting to the internet, be sure to connect via a device such as a router.**  
When the wireless LAN connection adapter function is turned on, the right side of the air conditioner may become slightly warm, but this is not an abnormality.

### ! WARNING

- While the Wireless LAN connection adapter operates, it may affect persons using cardiac pacemakers or defibrillators. This product may cause electromagnetic interference.
- While the Wireless LAN connection adapter operates, it may affect automatic doors or fire alarm equipment. This product may cause faulty behavior of the equipment.

## Configuration

- The user is responsible for providing the following items before using this product:

- Smartphone or tablet PC
- Internet line and communicating device (Modem/router or similar device)
- Wireless LAN access point
- Application name: [Daikin One Home] (free)

For details on the installation method for the Daikin One Home, please see ▶ Page 21.

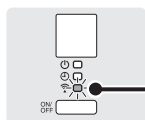

Display

### Wireless LAN connection adapter lamp (Orange)

- The Wireless LAN connection adapter lamp lights when connecting to a router (Wireless LAN access point). Please see ▶ Page 21.
- For Wireless LAN connection adapter operation, please see ▶ Page 22.

### ! WARNING

**When operating an air conditioner from outside the home, it is not possible to check the air conditioner or the surroundings of the air conditioner, or the state of the people in the room. Therefore, make sure to adequately check for safety before use.**

**In some cases, there is a risk of death, severe injury, or property damage.**

#### ■ Check the following in advance (while at home)

- Timer settings or reservations that other users may have made. (There is a risk of causing harm to the health of people, animals, or plants in the home if operation starts and stops unexpectedly)
- There are no signs of abnormality in the air conditioning. Harm will not be caused to people or to the room if there is a change in airflow. (For example, that there are no objects nearby that might blow over) (There is a risk of objects falling due to airflow and causing fire, bodily injury, or staining of household items)

#### ■ Check the following before/while operating a unit from outside the home

- If you know that there is someone at home, inform the person when turning the air conditioner on or off from outside the home. (If someone at home is standing on something such as a stool, the air conditioner turning on or off unexpectedly could surprise them and cause them to fall or topple over. Additionally, a sudden change in the indoor/outdoor temperature could harm the health of people at home)
  - The air conditioner can be turned off and temperature adjustment can be made using a remote controller in the home.
  - Do not use the function if the only people at home are persons who are unable to make adjustments to temperature or other settings themselves, such as young children, disabled persons, or elderly persons.

- Regularly check the settings and operating status of the air conditioner. (Sudden changes in indoor/outdoor temperature pose a health hazard. There is a risk of harm to animals and plants)

If an error occurs during operation, immediately turn off the air conditioner and contact your dealer.

Double check the display to confirm that the power is off.

# Preparation Before Operation

## CAUTION

Incorrect handling of batteries can result in injury from battery leakage, rupturing or heating, or lead to equipment failure.

Please observe the following precautions and use safely.

- If the alkaline solution from the batteries should get in the eyes, do not rub the eyes. Instead, immediately flush the eyes with tap water and seek the attention of a medical professional.
- Keep batteries out of reach of children. In the event that batteries are swallowed, seek the immediate attention of a medical professional.
- Do not expose batteries to heat or fire. Do not disassemble or modify batteries. The insulation or gas release vent inside the battery may be damaged, resulting in battery leakage, rupturing, or heating.
- Do not damage or peel off labels on the batteries.

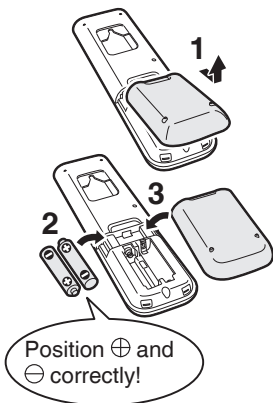

### To insert the batteries

1. Remove the back cover by sliding and then slightly lifting it.
2. Insert 2 dry batteries AAA.LR03 (alkaline).
3. Replace the back cover.

### To attach the remote controller holder to a wall

1. Choose a place where the signals reach the unit.
2. Attach the holder to a wall, a pillar, or similar location with the screws supplied with the holder.
3. Hang the remote controller on the remote controller holder.

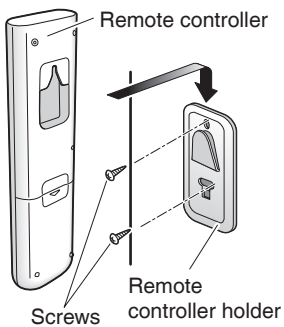

### Fahrenheit/Celsius display switch

Press  and  (TIMER button) simultaneously for about 5 seconds.

- The temperature will be displayed in Celsius when it is presently displayed in Fahrenheit, and vice versa.
- The switch operation is only possible when the temperature is being displayed.
- A reception sound will go off for the transmission of set temperature to the indoor unit at the time of setting the Fahrenheit/Celsius display change function.

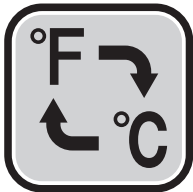

### Turn on the circuit breaker

- After the power is turned on, the flap of the indoor unit opens and closes once to set the reference position.

## NOTE

### Notes on batteries

- To avoid possible injury or damage from battery leakage or rupturing, remove the batteries when not using the product for long periods of time.
- The standard replacement time is about 1 year. Both batteries should be replaced at the same time. Be sure to replace them with new dry batteries AAA.LR03 (alkaline).
- If the remote controller display begins to fade and signal reception begins to decline, replace the batteries with new batteries. Owing to usage conditions, battery consumption may be accelerated.
- The batteries supplied with the remote controller are for initial operation. The batteries may run out in less than 1 year.

### Notes on remote controller

- Do not drop the remote controller. Do not get it wet.
- If dirt becomes an issue, wipe with a soft dry cloth.

### Fahrenheit/Celsius display change function of remote controller

- The set temperature may increase when the display is changed to Celsius from Fahrenheit, because a fraction of 0.5°C is rounded up.
- Example: A set temperature of 65°F (equivalent to 18.5°C) will be converted into 19°C. When the display is changed to Fahrenheit again, the set temperature will be converted into 66°F (equivalent to 19°C) instead of the original set temperature (65°F) but a set temperature of 66°F (equivalent to 19°C) will be converted into 19°C with no temperature change.



# AUTO · COOL · DRY · HEAT · FAN ONLY Operation



The air conditioner operates with the operation mode of your choice.

## To start operation

### AUTO operation

- To automatically select an appropriate temperature and operation mode.

Press **AUTO**.



### COOL operation

- To lower the temperature.

Press **COOL**.



### DRY operation

- To lower the humidity.

Press **DRY**.



### HEAT operation

- To raise the temperature.

Press **HEAT**.



### FAN ONLY operation

- To circulate air in the room.

Press **FAN ONLY**.



- The OPERATION lamp lights green.

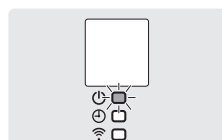

Display

## NOTE

### Notes on AUTO operation

- In AUTO operation, the system selects an appropriate operation mode (COOL or HEAT) based on the indoor temperature and starts the operation.
- The system automatically reselects setting at a regular interval to bring the indoor temperature to the user-setting level.

### Note on DRY operation

- Eliminates humidity while maintaining the indoor temperature as much as possible. It automatically controls temperature and airflow rate, so manual adjustment of these functions is unavailable.



# AUTO · COOL · DRY · HEAT · FAN ONLY Operation

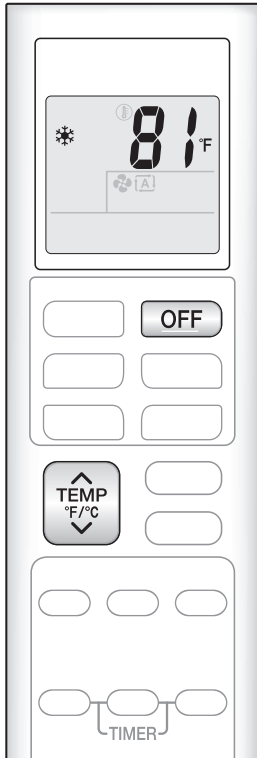

## To stop operation

Press **OFF**.

- The OPERATION lamp goes off.

## To change the temperature setting

Press **TEMP °F/°C**.

- Press **▲** to raise the temperature and press **▼** to lower the temperature.

COOL operation	HEAT operation	AUTO operation	DRY or FAN ONLY operation
64-90°F (18-32°C)	50-86°F (10-30°C)	64-86°F (18-30°C)	The temperature setting cannot be changed.

## Tips for saving energy

**Keeping the temperature setting at a moderate level helps save energy.**

- Recommended temperature setting
  - For cooling: 78-82°F (26-28°C)
  - For heating: 68-75°F (20-24°C)

**Cover windows with a blind or a curtain.**

- Blocking sunlight and air from outdoors increases the cooling (heating) effect.

**Keep the air filters clean.**

- Clogged air filters cause inefficient operation and waste energy. Clean them once in about every 2 weeks. [▶Page 26](#)

**If you are not going to use the air conditioner for a long period, for example in spring or autumn, turn off the circuit breaker.**

- The air conditioner always consumes a small amount of electricity even while it is not operating.





# Adjusting the Airflow Rate

You can adjust the airflow rate to increase your comfort.

## To adjust the airflow rate setting

Press **FAN**.

- Each pressing of **FAN** changes the airflow rate setting in sequence.



- When the airflow is set to “”, quiet operation starts and noise from the indoor unit will become quieter. However, it may become difficult to cool (or warm) the room.
- In the quiet operation mode, the airflow rate is set to a weak level.

AUTO, COOL, HEAT and FAN ONLY operation				DRY operation	
			→	The airflow rate setting cannot be changed. (only AUTO)	
					AUTO

## NOTE

### Note on airflow rate setting

- At smaller airflow rates, the cooling (heating) effect is also smaller.

### Note on AUTO airflow rate

- When using AUTO airflow rate, the airflow rate is adjusted according to conditions in the room.



# Adjusting the Airflow Direction

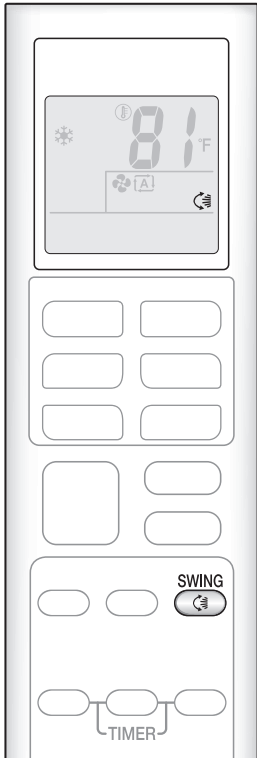

You can adjust the airflow direction to increase your comfort.

## CAUTION

- Always use a remote controller to adjust the angles of the flap. Moving the flap forcibly by hand may cause a malfunction.
- Be careful when adjusting the louvers. Inside the air outlet, a fan is rotating at a high speed.

### To start auto swing

#### Up and down airflow direction

Press .

- “” is displayed on the LCD.
- The flap (horizontal blade) will begin to swing.

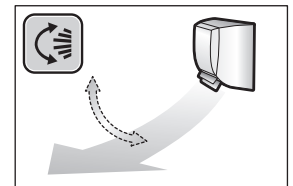

### To set the flap at the desired position

- This function is effective while the flap is in auto swing mode.

Press when the flap reaches the desired position.

- “” disappears from the LCD.

### To adjust the louvers at desired position

Hold the knobs and move the louvers (vertical blades).

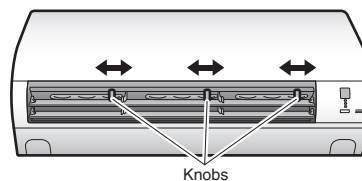

## NOTE

### Notes on airflow direction setting

- The movable range of the flap varies according to the operation mode.
- If the airflow rate becomes weak during operation, the flap will stop.  
When up and down airflow direction is set, the flap will stop in an upward position.

Movable range of the flap

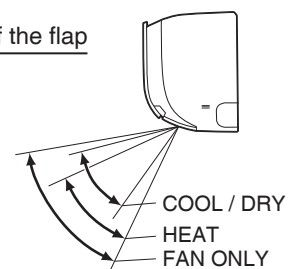



## COMFORT AIRFLOW Operation

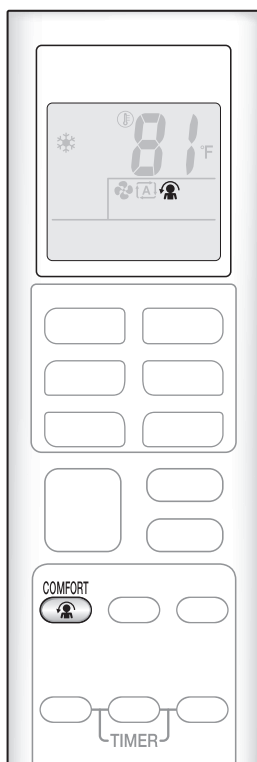

The flow of air will be in the upward direction while in COOL and DRY operation and in the downward direction while in HEAT operation, which will provide a comfortable airflow that will not come in direct contact with people.

### To start COMFORT AIRFLOW operation

Press  .

- “” is displayed on the LCD.

	COOL and DRY operation	HEAT operation	FAN operation
Flap direction	Goes up	Goes down	Not available
Airflow rate	AUTO		

- When in AUTO operation, the flap direction differs based on the operation mode (COOL or HEAT) as shown in the table above.

### To cancel COMFORT AIRFLOW operation

Press  again.

- “” disappears from the LCD.
- The flap will return to the memory position from before COMFORT AIRFLOW operation.



## POWERFUL Operation



POWERFUL operation quickly maximizes the cooling (heating) effect in any operation mode. In this mode, the air conditioner operates at maximum capacity.

### To start POWERFUL operation

Press  .

- “” is displayed on the LCD.
- POWERFUL operation ends in 20 minutes. Then the system automatically operates again with the previous settings which were used before POWERFUL operation.

### To cancel POWERFUL operation

Press  again.

- “” disappears from the LCD.



# ECONO Operation

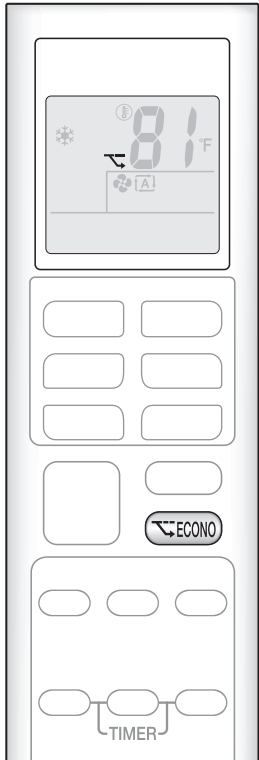

ECONO operation enables efficient operation by limiting the maximum power consumption.

This function is useful to prevent the circuit breaker from tripping when the unit operates alongside other appliances on the same circuit.

## To start ECONO operation

Press .

- “” is displayed on the LCD.
- Not available in FAN ONLY mode.

## To cancel ECONO operation

Press again.

- “” disappears from the LCD.

## NOTE

### Notes on COMFORT AIRFLOW operation

- The airflow rate will be set to AUTO.
- If the up and down airflow direction is selected, the COMFORT AIRFLOW operation will be canceled.

### Notes on POWERFUL operation

- Pressing causes the settings to be canceled, and “” disappears from the LCD.
- POWERFUL operation will not increase the capacity of the air conditioner if the air conditioner is already in operation with its maximum capacity demonstrated.

#### – In COOL, HEAT and AUTO operation

To maximize the cooling (heating) effect, the capacity of outdoor unit increases and the airflow rate becomes fixed at the maximum setting. The temperature and airflow settings cannot be changed in COOL and HEAT operation. Airflow settings cannot be changed in AUTO operation.

#### – In DRY operation

The temperature setting is lowered by 1.8°F (1.0°C) and the airflow rate is slightly increased.

#### – In FAN ONLY operation

The airflow rate is fixed at the maximum setting.

### Notes on ECONO operation

- This operation is performed with lower power and therefore may not provide a sufficient cooling (heating) effect.
- Pressing causes the settings to be canceled, and “” disappears from the LCD.
- If the power consumption level is already low, switching to ECONO operation will not reduce the power consumption.

### Some useful functions can be used together.

COMFORT AIRFLOW + ECONO	Available
POWERFUL + COMFORT AIRFLOW	Not available*
POWERFUL + ECONO	Not available*

\*Priority is given to the function of whichever button is pressed last.



# ON/OFF TIMER Operation

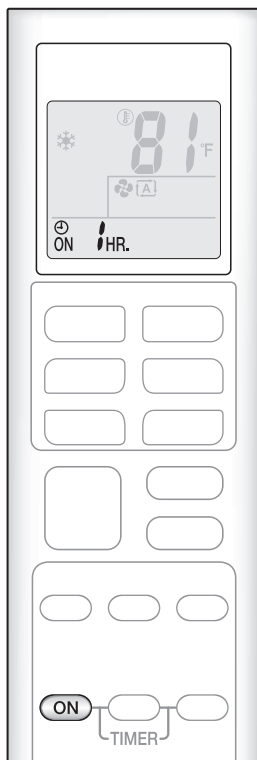

Timer functions are useful for automatically switching the air conditioner on or off in the morning or at night. You can also use the ON TIMER and OFF TIMER together.

## To use ON TIMER operation

▶ Press **ON**.

- Each pressing of **ON** changes the time setting by 1 hour. The time can be set between 1 and 12 hours.
- The TIMER lamp lights orange.

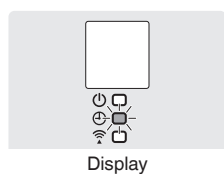

## NOTE

**In the following cases, set the timer again.**

- After the circuit breaker has turned off.
- After a power failure.
- After replacing the batteries in the remote controller.



# ON/OFF TIMER Operation

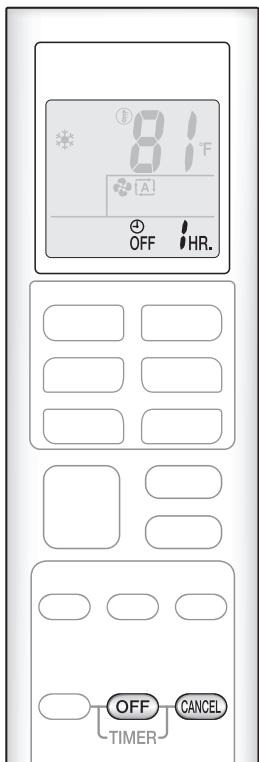

## To use OFF TIMER operation

▶ Press **OFF** .

- Each pressing of **OFF** changes the time setting by 1 hour. The time can be set between 1 and 12 hours.
- The TIMER lamp lights orange.

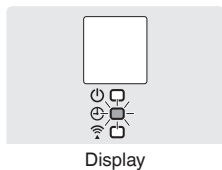

## To cancel ON/OFF TIMER operation

▶ Press **CANCEL** .

## To combine ON TIMER and OFF TIMER operation

- A sample setting for combining the 2 timers is shown below.
- “ON” and “OFF” are displayed on the LCD.

### [Example]

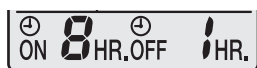

#### When setting while the unit is operating

- Stops the unit 1 hour later and starts it 7 hours after that.



#### When setting while the unit is stopped

- Starts the unit 2 hours later and stops it 3 hours after that.

## NOTE

### NIGHT SET mode

- When the OFF TIMER is set, the air conditioner automatically adjusts the temperature setting (0.9°F (0.5°C) up in COOL, 3.6°F (2.0°C) down in HEAT) to prevent excessive cooling (heating) during sleeping hours.

# Note for Multi System

A multi system has one outdoor unit connected to multiple indoor units.

## Selecting the operation mode

**When the priority room setting is active but the set unit is not operating or when the priority room setting is inactive**

When more than one indoor unit is operating, priority is given to the first unit that was turned on.

In this case, set the units that are turned on later to the same operation mode as the first unit.

Otherwise, they will enter the standby state, and the OPERATION lamp will blink; this does not indicate malfunction.

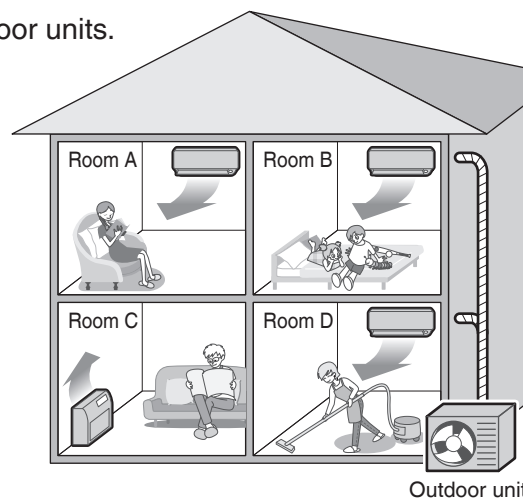

## NOTE

### Notes on operation mode for a multi system

- COOL, DRY and FAN operation may be used at the same time.
- AUTO operation automatically selects COOL operation or HEAT operation based on the indoor temperature. Therefore, AUTO operation is available when selecting the same operation mode as that of the room with the first unit to be turned on.

## CAUTION

- Normally, the operation mode in the room where the unit is first started is given priority, but the following situations are exceptions to this rule. If the operation mode of the first room is FAN operation, then using HEAT operation in any room after this will give priority to HEAT operation. In this situation, the indoor unit operating in FAN mode will switch to standby, and the OPERATION lamp will blink.

### With the priority room setting active

Refer to “**Priority room setting**” on the next page.

# Note for Multi System

## COOL/HEAT mode lock

The COOL/HEAT mode lock requires initial programming during installation. Please consult your authorized dealer for assistance. The COOL/HEAT mode lock sets the unit forcibly to either COOL or HEAT operation. This function is convenient when you wish to set all indoor units connected to the multi system to the same operation mode.

### NOTE

- The COOL/HEAT mode lock cannot be activated together with the priority room setting.

## Priority room setting (Not available on some models)

The priority room setting requires initial programming during installation. Please consult your authorized dealer for assistance. The room designated as the priority room takes priority in the following situations.

### Operation mode priority

- As the operation mode of the priority room takes precedence, you can select a different operation mode from other rooms.

#### [Example]

- Room A is the priority room in this example.  
When COOL operation is selected in room A while operating the following modes in room B, C and D:

Operation mode in room B, C and D	Status of room B, C and D when the unit in room A is in COOL operation
COOL or DRY or FAN	The current operation mode is maintained.
HEAT	The unit enters the standby mode. Operation resumes when the room A unit stops operating.
AUTO	If the unit is set to COOL operation, it continues. If the unit is set to HEAT operation, it enters the standby mode. Operation resumes when the room A unit stops operating.

### Priority when POWERFUL operation is used

#### [Example]

- Room A is the priority room in this example.  
The indoor units in rooms A, B, C and D are all operating. If the unit in room A enters POWERFUL operation, operation capacity will be concentrated in room A. In such a case, the cooling (heating) efficiency of the units in room B, C and D may be slightly reduced.



# Wireless LAN connection

## Wireless LAN connection



Web site: <https://daikinone.com/ductless>

For instructions on how to connect your unit to wireless LAN and to your Daikin One Home application, please see the website above.

Contains FCC ID: VPYLB1YA

This device complies with part 15 of the FCC Rules. Operation is subject to the following two conditions:

- (1) This device may not cause harmful interference, and
- (2) This device must accept any interference received, including interference that may cause undesired operation.

### FCC CAUTION

Changes or modifications not expressly approved by the party responsible for compliance could void the user's authority to operate the equipment.

This transmitter must not be co-located or operated in conjunction with any other antenna or transmitter.

Contains IC: 772C-LB1YA

This device complies with Industry Canada's applicable licence-exempt RSSs.

Operation is subject to the following two conditions:

- (1) This device may not cause interference; and
- (2) This device must accept any interference, including interference that may cause undesired operation of the device.

This equipment complies with IC radiation exposure limits set forth for an uncontrolled environment and meets RSS-102 of the IC radio frequency (RF)

Exposure rules. This equipment should be installed and operated keeping the radiator at least 7-7/8 inches (20cm) or more away from person's body.

The FCC responsible party is Daikin Comfort Technologies Manufacturing, L.P., and may be contacted by calling (713)-861-2500, or at 19001 Kermier Rd., Waller, TX 77484.

(<https://www.northamerica-daikin.com>)

This device, which was assembled by Daikin Comfort Technologies Manufacturing, L.P., contains a component that is classified as an intentional radiator.

This intentional radiator has been certified by the FCC: FCC ID VPYLB1YA.

And this intentional radiator has an industry Canada ID: IC 772C-LB1YA.

The manufacturer of the intentional radiator (model no. Type1YA) is Murata Manufacturing co., Ltd ([www.murata.com](http://www.murata.com)).

This equipment complies with FCC radiation exposure limits set forth for an uncontrolled environment and meets the FCC radio frequency (RF) Exposure Guidelines. This equipment should be installed and operated keeping the radiator at least 7-7/8 inches (20cm) or more away from person's body.

Changes or modifications not expressly approved by the party responsible for compliance could void the user's authority to operate the equipment.

NOTE: This equipment has been tested and found to comply with the limits for a Class B digital device, pursuant to part 15 of the FCC Rules. These limits are designed to provide reasonable protection against harmful interference in a residential installation. This equipment generates, uses and can radiate radio frequency energy and, if not installed and used in accordance with the instructions, may cause harmful interference to radio communications. However, there is no guarantee that interference will not occur in a particular installation. If this equipment does cause harmful interference to radio or television reception, which can be determined by turning the equipment off and on, the user is encouraged to try to correct the interference by one or more of the following measures:

- Reorient or relocate the receiving antenna.
- Increase the separation between the equipment and receiver.
- Connect the equipment into an outlet on a circuit different from that to which the receiver is connected.
- Consult the dealer or an experienced radio/TV technician for help.



# Wireless LAN connection

## Application software installation

### For Android Phones

- 1) Open [Google Play].
- 2) Search using the application name: [Daikin One Home].
- 3) Follow the directions on the screen to install.

### For iOS Phones

- 1) Open the [App Store].
- 2) Search using the application name: [Daikin One Home].
- 3) Follow the directions on the screen to install.

### Attention

- The actual application screen layout and content may differ from what is shown. The layout and content of the application screen is subject to change without notice.

Connect the air conditioner to your home network.

**1.** While operation is stopped, press  and hold the button for 5 seconds.

**2.** Press  or  and select menu number **3**.

- “SP” appears on the LCD.
- “3” blinks.

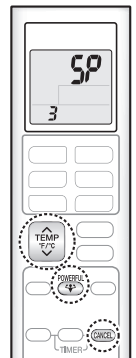
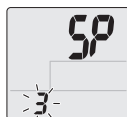

**3.** Press  to connect to the access point.

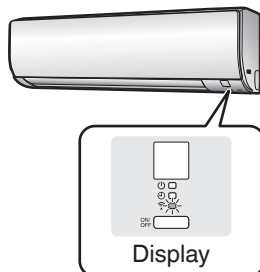

The wireless LAN connection adapter lamp blinks quickly.



**4.** Press  to return to the default screen.

No more settings need to be carried out from the remote controller.

**5.** Open Daikin One Home App and follow the instructions to set up the wireless LAN.

**6.** When the wireless LAN connection adapter lamp switches from blinking to lit, the connection is complete.

## NOTE

- While “SP” is displayed, the options that can be selected using  and  are 1, 3, A, and OFF.
- Perform wireless LAN connection one indoor unit at a time.
- If you are unable to establish a network connection, refer the troubleshooting provided by the Daikin One Home App.
- When the lamp blinks slowly, the connection is not ready. Perform the connection procedure while it blinks quickly.

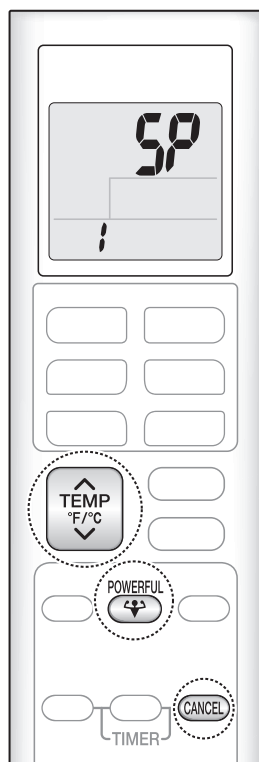

## To confirm the wireless LAN connection adapter connection

### ■ To confirm

1. While operation is stopped, press  and hold the button for 5 seconds.
2. Press  to confirm the selected setting.

- “SP” appears on the LCD.
- “!” blinks.

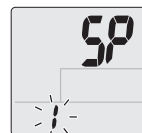

### Check the indoor unit LED.

Wireless LAN connection adapter lamp	Status
Blinking for 1 second	Connection is not ready
Blinking for 3 seconds	Please initialize the wireless LAN connection adapter
Does not blink or light	Communication is abnormal There is a possibility of equipment failure Please request repair

## To turn off the wireless connection

### ■ To use the remote controller

1. While operation is stopped, press  and hold the button for 5 seconds.

2. Press  or  and select menu OFF.

- “SP” appears on the LCD.
- “OFF” blinks, and communication is OFF.

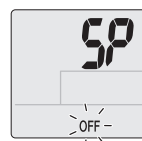

3. Press  and hold the button for 2 seconds to confirm selected setting.

- The wireless LAN connection adapter lamp turn off.

4. Press  to return to the default screen.

## To reset the connection setting to the factory default

- If you want to reset the connection settings, it is possible to initialize the wireless LAN connection adapter to its factory default state. If initialized, data including the network settings and power consumption history will be erased.
- When discarding or transferring to another user, initialize the connection adapter to erase the internal data.

### ■ To reset

1. While operation is stopped, press  and hold the button for 5 seconds.

2. Press  or  and select menu R.

- “SP” appears on the LCD.
- “R” blinks.

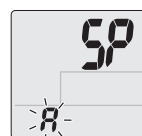

3. Press  and hold the button for 2 seconds to confirm selected setting.

- The wireless LAN connection adapter lamp blinks for 1 second.

4. Press  to return to the default screen.

# Brightness of Indoor Unit LED Lamps

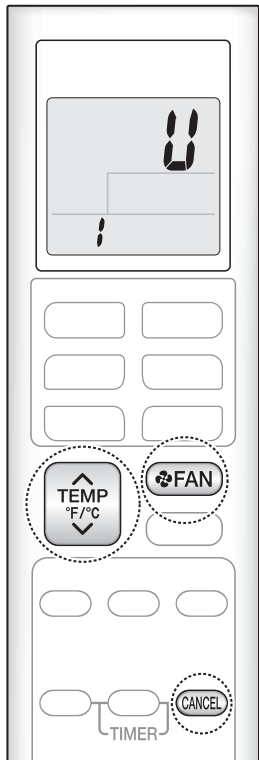

Changes can be made to the setting for the brightness of the LED lamps, to suit your preferences.

**1.** While operation is stopped, press **FAN** and hold the button for 5 seconds.

**2.** Press **TEMP F/C** and select menu number **i**.

- “U” appears on the LCD.
- “i” blinks.

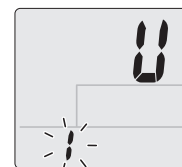

**3.** Press **FAN**.

**4.** Press **TEMP F/C** or **TEMP F/C** and select setting option.

- The setting option will blink.

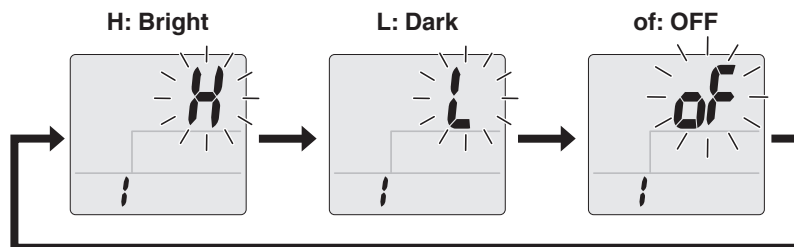

**5.** Press **FAN**.

**6.** Press **FAN** and hold the button for 5 seconds to return to the default screen.

## NOTE

- Press **CANCEL** to return to the previous screen.
- If no operations are performed for approximately 1 minute, the display will return to the default screen.
- Indoor unit default setting: H (Bright)

# Airflow Setting When Indoor Unit Reaches Setpoint

Changes can be made to the setting for airflow rate when unit reaches desired temperature (setpoint), to suit your preferences.

This function is effective when COOL operation is selected.

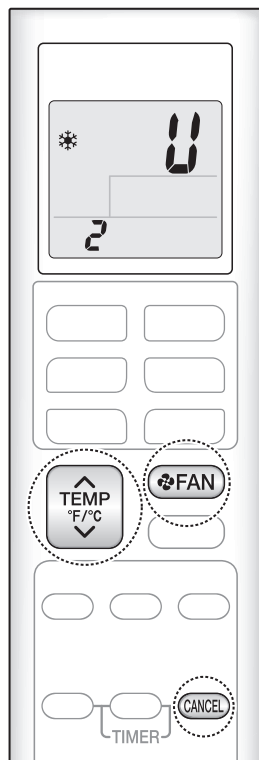

**1.** While operation is stopped, press **FAN** and hold the button for 5 seconds.

**2.** Press **TEMP F/C** or **TEMP F/C** and select menu number **2**.

- “U” appears on the LCD.
- “2” blinks.

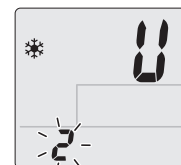

**3.** Press **FAN**.

**4.** Press **TEMP F/C** or **TEMP F/C** and select setting option.

- The setting option will blink.

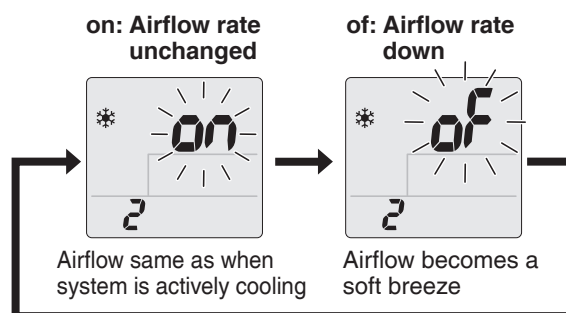

**5.** Press **FAN**.

**6.** Press **FAN** and hold the button for 5 seconds to return to the default screen.

## NOTE

- Press **CANCEL** to return to the previous screen.
- If no operations are performed for approximately 1 minute, the display will return to the default screen.
- Indoor unit default setting: of (Airflow rate down)

# Care and Cleaning

## ⚠ CAUTION

- Before cleaning, be sure to stop the operation and turn off the circuit breaker.
- Do not touch the aluminum fins of the indoor unit. If you touch those parts, this may cause an injury.

## ■ Quick reference

### Cleaning parts

#### Front panel

- Wipe with a soft cloth which has been moistened with water or neutral detergent.
- Only neutral detergent may be used.

**If dirty**

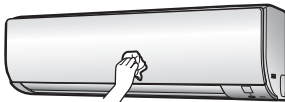

#### Air filter

- Vacuum dust or wash the filter.

**Once every 2 weeks**

▶ Page 26

#### Indoor unit, outdoor unit and remote controller

- Wipe them with a soft cloth.

**If dirty**

#### Titanium apatite deodorizing filter (with frame)

- Vacuum dust or replace the filter.

[Cleaning]

**Once every 6 months**

▶ Page 27

[Replacement]

**Once every 3 years**

▶ Page 27

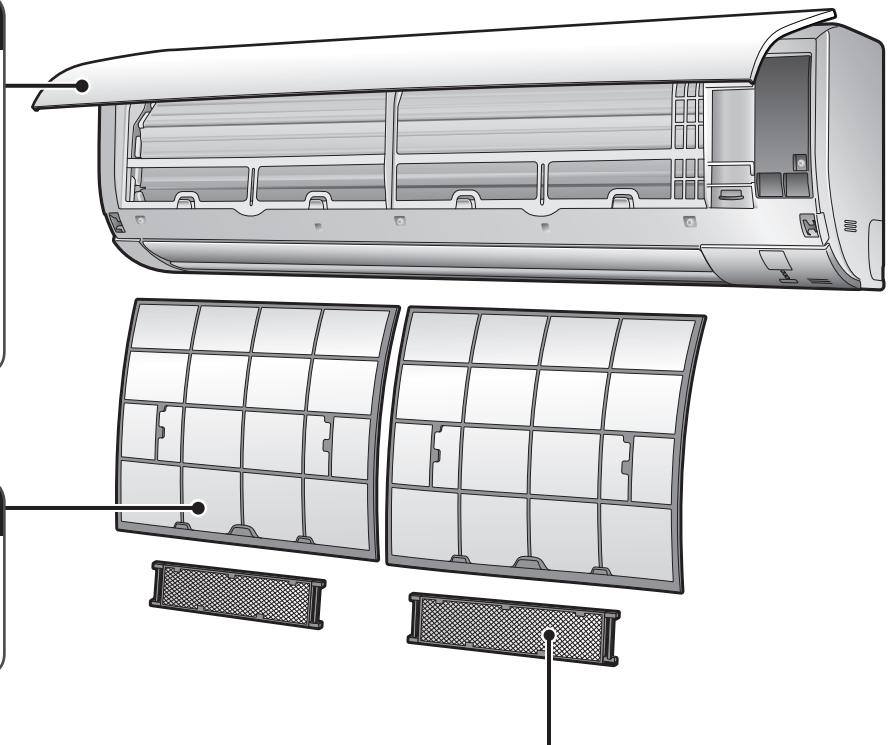

## NOTE

For cleaning, do not use any of the following:

- Water hotter than 104°F (40°C)
- Volatile liquid such as benzine, gasoline and thinner
- Polishing compounds
- Rough materials such as a scrubbing brush
- Sprays such as deodorizers



## ■ Air filter

### 1. Open the front panel.

- Hold the front panel by the sides and open it.

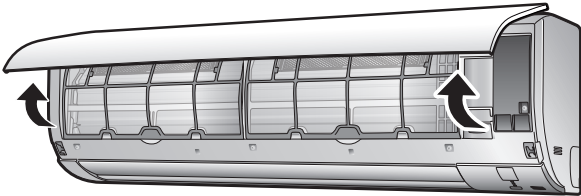

### 2. Pull out the air filters.

- Push the filter tab at the center of each air filter a little upwards, then pull it down.

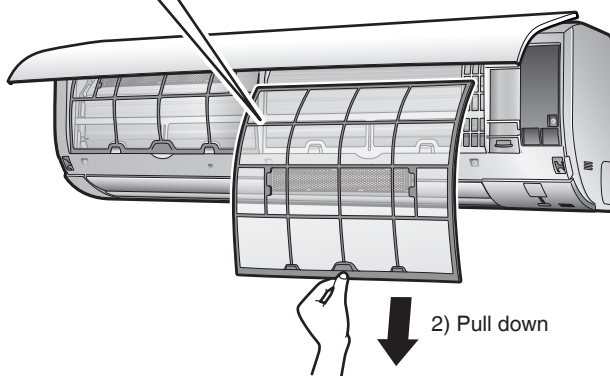
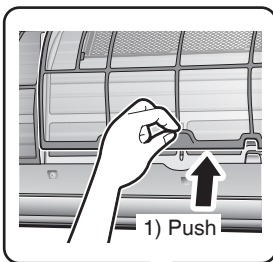

### 3. Wash the air filters with water or clean them with vacuum cleaner.

- It is recommended to clean the air filters every 2 weeks.

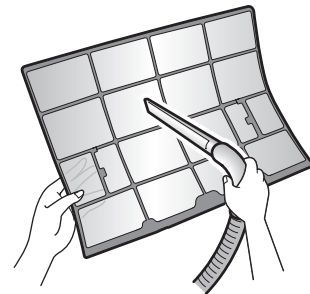

#### If the dust does not come off easily

- Wash the air filters with neutral detergent thinned with lukewarm water, then dry them up in the shade.
- Be sure to remove the titanium apatite deodorizing filter. Refer to “Titanium apatite deodorizing filter”. ▶Page 27

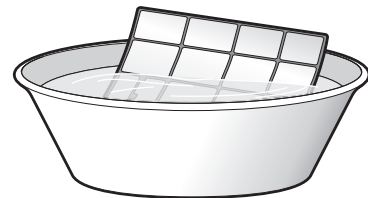

### 4. Reattach the filters.

### 5. Close the front panel slowly.

- Press the front panel at both sides and in the central area.

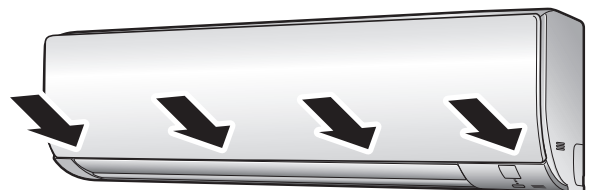

- Make sure that the front panel is securely fixed.

# Care and Cleaning

## ■ Titanium apatite deodorizing filter

**1. Open the front panel and pull out the air filters.** ▶Page 26

**2. Take off the titanium apatite deodorizing filters.**

- Hold the recessed parts of the frame and unhook the 4 claws.
- Remove the filters from the tab.

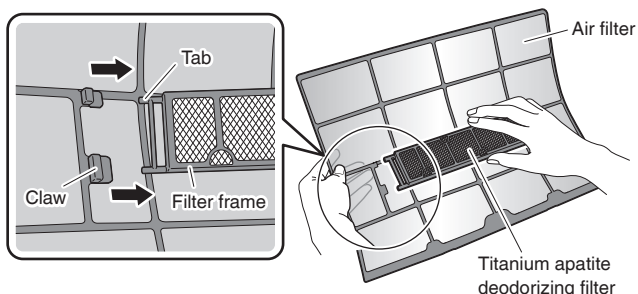

**3. Clean or replace the titanium apatite deodorizing filters.**

### [Cleaning]

**3-1 Vacuum dust, and soak in lukewarm water or water for about 10 to 15 minutes if very dirty.**

- Do not remove the filter from the frame when washing with water.

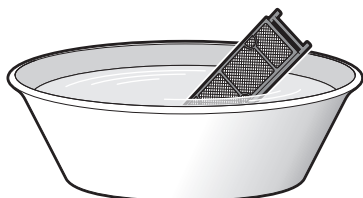

**3-2 After washing, shake off remaining water and let them dry in the shade.**

- Do not wring out the filter to remove water from it.

### [Replacement]

**Remove the filter from the filter frame and prepare a new one.**

- Do not throw away the filter frame. Reuse the filter frame when replacing the titanium apatite deodorizing filter.

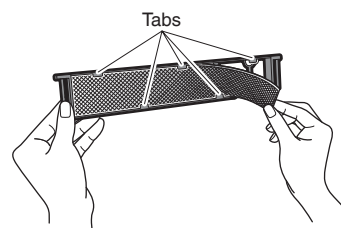

- Dispose of the old filter as non-flammable waste.

**4. Set the titanium apatite deodorizing filters as they were.**

- When attaching the filter, check that the filter is properly set in the tabs.
- The titanium apatite deodorizing filter can be attached in any orientation.

**5. Reattach the filters.** ▶Page 26

**6. Close the front panel slowly.**

▶Page 26

### NOTE

- Operation with dirty filters:
  - cannot deodorize the air,
  - cannot clean the air,
  - results in poor heating or cooling,
  - may cause odor.
- Dispose of old filters as non-flammable waste.
- To order a titanium apatite deodorizing filter, contact the dealer where you bought the air conditioner.

Item	Titanium apatite deodorizing filter 1 set (2 pieces)
Part No.	KAF970A46 (without frame)
	KAF970A45 (with frame)

## ■ Prior to a long period of non-use

### 1. Operate the FAN ONLY mode for several hours on a mild day to dry out the inside.

- Press  .

### 2. After operation stops, turn off the circuit breaker for the room air conditioner.

### 3. Clean the air filters and reattach them.

### 4. To prevent battery leakage, take out the batteries from the remote controller.

- When starting to use the air conditioner again, make sure that the drain hose outlet is not blocked, then turn on the circuit breaker.  
An operational check of each component will be carried out automatically. (Also, put the batteries into the remote controller.)

## ■ We recommend periodical maintenance

- In certain operating conditions, the inside of the air conditioner may get foul after several seasons of use, resulting in poor performance. It is recommended to have periodical maintenance by a qualified contractor in addition to regular cleaning by the user.
- For qualified contractor maintenance, please contact the dealer where you bought the air conditioner.

# FAQ

## Indoor unit

### The flaps do not start swinging immediately.

- The air conditioner is adjusting the position of the flaps. The flaps will start moving soon.

### The air conditioner stops generating airflow during HEAT operation.

- Once the set temperature is reached, the airflow rate is reduced and operation stopped in order to avoid generating a cool airflow. Operation will resume automatically when the indoor temperature falls.

### HEAT operation stops suddenly and a flowing sound is heard.

- The outdoor unit is defrosting. HEAT operation starts after the frost on the outdoor unit has been removed. This can take about 4 to 12 minutes.

### Operation does not start soon.

- **When the unit is turned on again soon after being turned off.**
- **When the mode was reselected.**
  - This is to protect the air conditioner. You should wait for about 3 minutes.

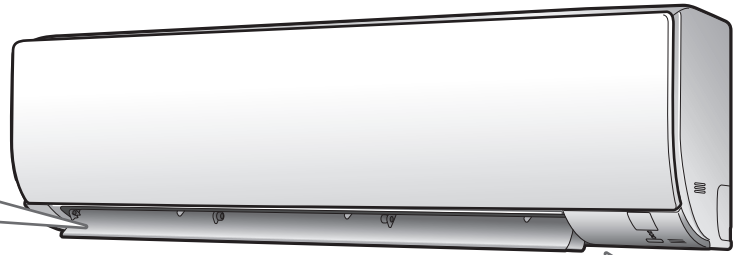

### Different sounds are heard.

- **A sound like flowing water**
  - This sound is generated because the refrigerant in the air conditioner is flowing.
  - This is a pumping sound of the water in the air conditioner and can be heard when the water is pumped out from the air conditioner during COOL or DRY operation.
  - The refrigerant flows in the air conditioner even if the air conditioner is not working when the indoor units in other rooms are in operation.
- **Blowing sound**
  - This sound is generated when the flow of the refrigerant in the air conditioner is switched over.
  - If the outdoor temperature is low, this sound is generated when the direction of the flow of the refrigerant in the piping changes at the start of defrost operation, after HEAT operation is stopped and the room temperature is stabilized.
- **Ticking sound**
  - This sound is generated when the cabinet and frame of the air conditioner slightly expand or shrink as a result of temperature changes.
- **Whistling sound**
  - This sound is generated when refrigerant flows during defrosting operation.
- **Clicking sound during operation or idle time**
  - This sound is generated when the refrigerant control valves or the electrical parts operate.
- **Clopping sound**
  - This sound is heard from the inside of the air conditioner when the exhaust fan is activated while the room doors are closed. Open the window or turn off the exhaust fan.

## Outdoor unit

### Operating sound is loud.

- When frost forms on the heat exchanger of the outdoor unit, the operating sound level increases slightly.

### The outdoor unit emits water or steam.

- **In HEAT operation**
  - The frost on the outdoor unit melts into water or steam when the air conditioner is in defrosting operation.
- **In COOL or DRY operation**
  - Moisture in the air condenses into water on the cool surface of the outdoor unit piping and drips.

### Blowing sound

- If the outdoor temperature is low, this sound is generated when the direction of the flow of the refrigerant in the piping changes at the start of defrost operation, after HEAT operation is stopped and the room temperature is stabilized.

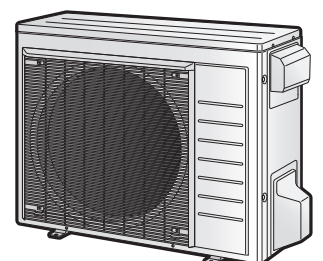

# Troubleshooting

Before making an inquiry or a request for repair, please check the following.  
If the problem persists, consult your dealer.



## Not a problem

This case is not a problem.



## Check

Please check again before requesting repairs.

### The air conditioner does not operate

Case	Description / what to check
OPERATION lamp is off.	<ul style="list-style-type: none"> <li>• Has the circuit breaker been tripped or the fuse blown?</li> <li>• Is there a power failure?</li> <li>• Are batteries set in the remote controller?</li> </ul>
OPERATION lamp is blinking.	<ul style="list-style-type: none"> <li>• Turn off the power with the circuit breaker and restart operation with the remote controller.</li> </ul> <p>If the OPERATION lamp is still blinking, check the error code and consult your dealer. ▶ <a href="#">Page 33, 34</a></p>

### The air conditioner suddenly stops operating

Case	Description / what to check
OPERATION lamp is on.	<ul style="list-style-type: none"> <li>• To protect the system, the air conditioner may stop operating after sudden large voltage fluctuations. It automatically resumes operation in about 3 minutes.</li> </ul>
OPERATION lamp is blinking.	<ul style="list-style-type: none"> <li>• Are the air filters dirty? Clean the air filters.</li> <li>• Is there anything blocking the air inlet or air outlet of the indoor unit or outdoor unit? Stop operation and after turning off the circuit breaker, remove the obstruction. Then restart operation with the remote controller. If the OPERATION lamp is still blinking, check the error code and consult your dealer. ▶ <a href="#">Page 33, 34</a></li> <li>• Are operation modes all the same for indoor units connected to outdoor units in the multi system? If not, set all indoor units to the same operation mode and confirm that the lamps. Moreover, when the operation mode is in AUTO, set all indoor unit operation modes to COOL or HEAT for a moment and check again that the lamps are normal. If the lamps stop blinking after the above steps, there is no malfunction. ▶ <a href="#">Page 18, 19</a></li> </ul>

### The air conditioner does not stop operating

Case	Description / what to check
The air conditioner continues operating even after operation is stopped.	<ul style="list-style-type: none"> <li>■ <b>Immediately after the air conditioner is stopped</b> <ul style="list-style-type: none"> <li>• The outdoor unit fan continues rotating for about another 1 minute to protect the system.</li> </ul> </li> <li>■ <b>While the air conditioner is not in operation</b> <ul style="list-style-type: none"> <li>• When the outdoor temperature is high, the outdoor unit fan may start rotating to protect the system.</li> </ul> </li> </ul>

### Wireless LAN connection

When this happens	Explanation and where to check
The device (air conditioner) cannot be found on the device list screen.	<ul style="list-style-type: none"> <li>• Carry out connection setting again while the lamp blinks quickly.</li> <li>• Move the router (wireless LAN access point) close to the indoor unit. ▶ <a href="#">Page 20-22</a></li> <li>• There is a possibility that you are using an unsupported smart phone or router (wireless LAN access point). For details, refer to the web site. ▶ <a href="#">Page 20-22</a></li> </ul>
Even if the wireless LAN connection adapter lamp is lit, operation from outside the home is not possible.	<ul style="list-style-type: none"> <li>• Communication between the router and the internet connection may not be working. Please confirm.</li> </ul>

# Troubleshooting

## The room does not cool down / warm up

Case	Description / what to check
Air does not come out.	<ul style="list-style-type: none"> <li><input checked="" type="checkbox"/> ■ <b>In HEAT operation</b> <ul style="list-style-type: none"> <li>• The air conditioner is warming up. Wait for about 1 to 4 minutes.</li> <li>• During defrosting operation, hot air does not flow out of the indoor unit.</li> </ul> </li> <li>■ <b>When the air conditioner operates immediately after the circuit breaker is turned on</b> <ul style="list-style-type: none"> <li>• The air conditioner is preparing to operate. Wait for about 3 to 10 minutes.</li> <li>• When the outdoor temperature is below 40°F (5°C) and heating operation is started, the air conditioner is warming up. Wait for about 10 to 25 minutes.</li> </ul> </li> </ul>
Air does not come out / Air comes out.	<ul style="list-style-type: none"> <li><input type="checkbox"/> ■ <b>Is the airflow rate setting appropriate?</b> <ul style="list-style-type: none"> <li>• Is the airflow rate setting low, such as “Indoor unit quiet” or “Airflow rate 1”? Increase the airflow rate setting.</li> </ul> </li> <li>■ <b>Is the set temperature appropriate?</b></li> <li>■ <b>Is the adjustment of the airflow direction appropriate?</b></li> </ul>
Air comes out.	<ul style="list-style-type: none"> <li><input type="checkbox"/> ■ <b>Is there any furniture directly under or beside the indoor unit?</b></li> <li>• Is the air conditioner in ECONO operation? <a href="#">▶Page 15</a></li> <li>• Are the air filters dirty?</li> <li>• Is there anything blocking the air inlet or air outlet of the indoor unit or outdoor unit?</li> <li>• Is a window or door open?</li> <li>• Is an exhaust fan turning?</li> <li>• Depending on the room conditions, number of occupants, or outdoor temperature and humidity, the set temperature may not be reached.</li> </ul> <p>A temperature regulation function which factors in living space conditions is available. For further details, please contact your dealer.</p>

## Water or mist comes out

Case	Description / what to check
Mist comes out of the indoor unit.	<ul style="list-style-type: none"> <li><input checked="" type="checkbox"/> • This happens when the air in the room is cooled into mist by the cold airflow during COOL or other operation.</li> </ul>
Water is leaking from the indoor unit.	<ul style="list-style-type: none"> <li><input type="checkbox"/> • If the drain hose is crushed or clogged, water from the indoor unit may be unable to drain and start leaking. Stop operation of the unit immediately and contact your dealer.</li> </ul>



## Remote controller

Case	Description / what to check
The unit does not receive signals from the remote controller or has a limited operating range.	<ul style="list-style-type: none"> <li><input checked="" type="checkbox"/> • The batteries may be exhausted. Replace both batteries with new dry batteries AAA.LR03 (alkaline). For details, refer to “<b>Preparation Before Operation</b>”. <a href="#">▶Page 9</a></li> <li>• Signal communication may be disabled if an electronic-starter-type fluorescent lamp (such as inverter-type lamps) is in the room. Consult your dealer if that is the case.</li> <li>• The remote controller may not function correctly if the transmitter is exposed to direct sunlight.</li> <li>• Is there a device in the room that redirects remote controller signals? Some appliances such as TV speakers are equipped with these devices. If there is such a device in the room, the signals it emits may interfere with signals from the remote controller, preventing reception.</li> <li>• Infrared rays from smartphones and game consoles may interfere with signals from the remote controller, preventing reception.</li> </ul>
LCD is faint, is not working, or the display is erratic.	<ul style="list-style-type: none"> <li><input checked="" type="checkbox"/> • The batteries may be exhausted. Replace both batteries with new dry batteries AAA.LR03 (alkaline). For details, refer to “<b>Preparation Before Operation</b>”. <a href="#">▶Page 9</a></li> </ul>
The LCD is blinking and the remote controller cannot be operated.	<ul style="list-style-type: none"> <li><input checked="" type="checkbox"/> • Battery power has run out. Replace both batteries at the same time with new size AAA.LR03 (alkaline) batteries. Leaving exhausted batteries in the remote controller can result in injury due to battery leakage, rupturing or heating, or lead to equipment failure. (Even when the LCD is blinking, the OFF button remains functional.)</li> </ul>
Other electric devices start operating.	<ul style="list-style-type: none"> <li><input checked="" type="checkbox"/> • If the remote controller activates other electric devices, move them away or consult your dealer.</li> </ul>

## Air has an odor

Case	Description / what to check
The air conditioner gives off an odor.	<input checked="" type="checkbox"/> • The room odor absorbed in the unit is discharged with the airflow. We recommend you to have the indoor unit cleaned. Please consult your dealer.
	<input checked="" type="checkbox"/> • The indoor unit is blowing out room odor it has absorbed (the smell of walls or carpeting, furniture, clothes, and so on). If the air conditioner has been used for a long time, there is a chance that a dirty heat exchanger or fan are emitting an odor. We recommend you to have the indoor unit cleaned. Please consult your dealer. Do not spray the air conditioner unit with any deodorizers.

## Display lamp

Case	Description / what to check
The unit operates even though the OPERATION lamp is off.	<input type="checkbox"/> • Is lamp brightness set to “  ”? ▶Page 23
The LED lamps on the unit are dim.	<input type="checkbox"/> • Is lamp brightness set to “  ”? ▶Page 23

## Others

Case	Description / what to check
The air conditioner suddenly starts behaving strangely during operation.	<input type="checkbox"/> • The air conditioner may malfunction due to lightning or radio. If the air conditioner malfunctions, turn off the power with the circuit breaker and restart the operation with the remote controller.
The ceiling and walls around the indoor unit are black and dirty.	<input checked="" type="checkbox"/> • Due to the circulation pattern of the air and static electricity, the air conditioner is causing airborne dirt and dust to stick to walls and other surfaces. Depending on the wallpaper type, dirt may adhere more easily. A thorough cleaning of the area around the air conditioner is recommended.

## Notes on the operating conditions

- If operation continues under any conditions other than those listed in the table,
  - A safety device may activate to stop the operation.
  - Dew may form on the indoor unit and drip from it when COOL or DRY operation is selected.
- \*1 Cutting the jumper on the outdoor unit PCB will extend the cooling operation range to 14°F (–10°C).  
Installing an air direction adjustment grille (sold separately) will further extend the operation range to –4°F (–20°C).  
Please consult your dealer.
- \*2 Installing a drain pan heater (sold separately) will further extend the heating operation range to –13°F (–25°C).  
Please consult your dealer.

Mode	Operating conditions
COOL / DRY	Outdoor temperature
	[RXT models] : 50*1 - 115°F (10*1 - 46°C)
	[MXM, MXT, MXTH models] : 14 - 115°F (–10 - 46°C)
	*1 –4°F (–20°C) if an air direction adjustment grille (sold separately) is installed.
Indoor temperature	: 64 - 90°F (18 - 32°C)
Indoor humidity	: 80% max.
HEAT	Outdoor temperature
	[MXM models] : 5 - 75°F (–15 - 24°C)
	[RXT, MXT models] : 5*2 - 75°F (–15*2 - 24°C)
	[MXTH models] : –13 - 75°F (–25 - 24°C)
	*2 –13°F (–25°C) if a drain pan heater (sold separately) is installed.
Indoor temperature	: 50 - 86°F (10 - 30°C)

# Troubleshooting

## The OPERATION lamp blinks

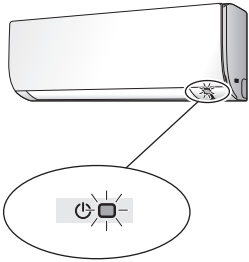

### ■ Check the interval time between blinks of the OPERATION lamp.

#### If connecting to multiple indoor units

##### [Blink interval of about 2 to 3 seconds]

Check the operation mode of any indoor units connected in other rooms.

Because this is a multi system air conditioner, it has one outdoor unit connected to multiple indoor units in different rooms.

If the operation mode is different from the operation mode of the indoor unit in another room, the OPERATION lamp may blink and operation may not be performed, or operation may stop while in progress.

COOL, DRY and HEAT operation may not be used at the same time.

##### [Blink interval of about 0.5 seconds]

This is a notification of an abnormality.

Check the error code following the procedure below, and respond according to the instructions in the table.



### ■ Fault diagnosis by remote controller



**1.** When **CANCEL** is held down for about 5 seconds, “00” blinks in the temperature display section.

**2.** While pointing the remote controller at the indoor unit, press **CANCEL** repeatedly.

A beep indicates a non-corresponding error code.

A long beep indicates a corresponding error code.

**3.** When a long beep is produced, check the error code and respond according to the instructions in the table.

- To cancel the code display, hold down **CANCEL** for about 5 seconds (the code display also clears if no button is pressed for a while).

CODE	Cause	Description / what to check
E7	The fan of the outdoor unit is stopped. • Is there any foreign matter inside the outdoor unit?	After turning off the circuit breaker, remove the foreign matter, then turn the power on again and operate.
L3, L4, L5	The temperature inside the outdoor unit has become too high, so operation has stopped. • Is there anything blocking the air outlet of the outdoor unit?	After turning off the circuit breaker, remove the obstruction, then turn the power on again and operate.
Other error codes, or if the error code cannot be checked		An abnormality has occurred.

In the case of error code **U0** or **F3**

	CODE	MEANING
SYSTEM	00	NORMAL
	UA	INDOOR-OUTDOOR UNIT COMBINATION FAULT
	U0	REFRIGERANT SHORTAGE
	U2	DROP VOLTAGE OR MAIN CIRCUIT OVERVOLTAGE
	U4	FAILURE OF TRANSMISSION (BETWEEN INDOOR UNIT AND OUTDOOR UNIT)
INDOOR UNIT	A1	INDOOR PCB DEFECTIVENESS
	A5	HIGH PRESSURE CONTROL OR FREEZE-UP PROTECTOR
	A6	FAN MOTOR FAULT
	C4	FAULTY HEAT EXCHANGER TEMPERATURE SENSOR
	C9	FAULTY SUCTION AIR TEMPERATURE SENSOR
	CC	FAULTY HUMIDITY SENSOR
OUTDOOR UNIT	EA	COOLING-HEATING SWITCHING ERROR
	E1	CIRCUIT BOARD FAULT, ELECTRONIC EXPANSION VALVE COIL DRIVER FAULT
	E3*	HIGH PRESSURE SWITCH (HPS) ACTIVATED
	E5	OL (COMPRESSOR OVERLOAD) STARTED, HIGH PRESSURE SWITCH (HPS) ACTIVATED*
	E6	FAULTY COMPRESSOR START UP
	E7	DC FAN MOTOR FAULT
	E8	OVERCURRENT INPUT
	E9	ELECTRONIC EXPANSION VALVE COIL FAULT
	F3	HIGH TEMPERATURE DISCHARGE PIPE CONTROL
	F6	HIGH PRESSURE CONTROL (IN COOLING)
	F8	OPERATION HALT DUE TO COMPRESSOR INTERNAL TEMPERATURE ABNORMALITY
	H0	SENSOR FAULT
	H3	HIGH PRESSURE SENSOR ABNORMALITY
	H6	OPERATION HALT DUE TO FAULTY POSITION DETECTION SENSOR
	H7	FAN IPM TEMPERATURE ERROR
	H8	DC CURRENT SENSOR FAULT
	H9	FAULTY SUCTION AIR TEMPERATURE SENSOR
	J3	FAULTY DISCHARGE PIPE TEMPERATURE SENSOR
	J6	FAULTY HEAT EXCHANGER TEMPERATURE SENSOR
	L3	ELECTRICAL PARTS HEAT FAULT
L4	HIGH TEMPERATURE AT INVERTER CIRCUIT HEATSINK	
L5	OUTPUT OVERCURRENT	
P4	FAULTY INVERTER CIRCUIT HEATSINK TEMPERATURE SENSOR	

\*The contents of the error differ depending on the connected outdoor unit.

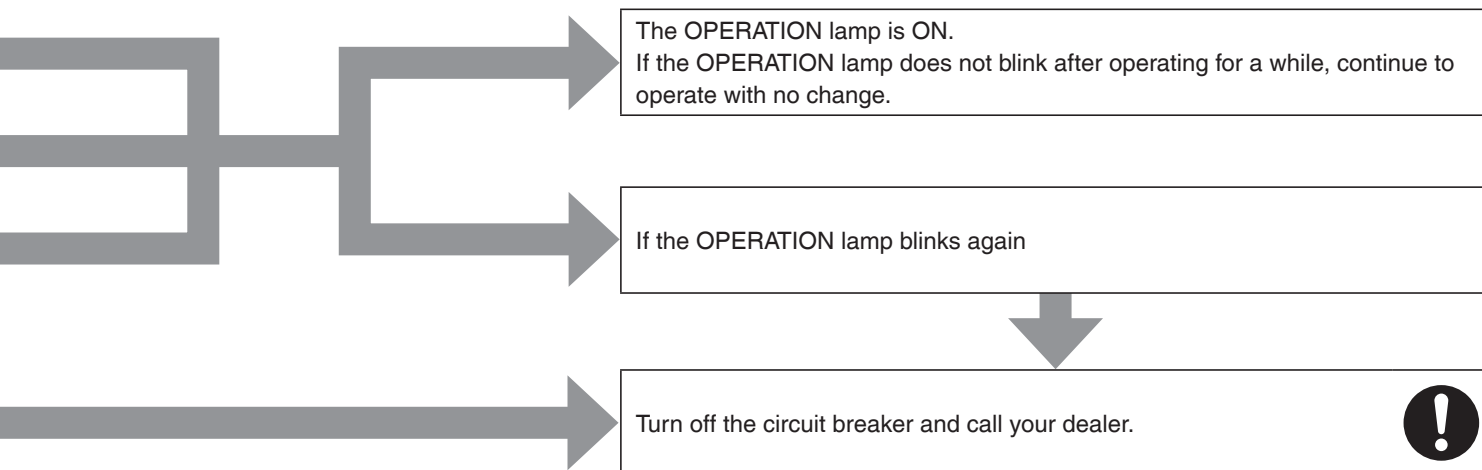

# Troubleshooting

## ■ Call your dealer immediately

### WARNING

**When an abnormality (such as a burning smell) occurs, stop operation and turn off the circuit breaker.**

- Continued operation in an abnormal condition may result in problems, electric shock or fire.
- Consult the dealer where you bought the air conditioner.

**Do not attempt to repair or modify the air conditioner by yourself.**

- Incorrect work may result in electric shock or fire.
- Consult the dealer where you bought the air conditioner.

**If one of the following symptoms takes place, call your dealer immediately.**

- The power cord is abnormally hot or damaged.
- An abnormal sound is heard during operation.
- The circuit breaker cuts off the operation frequently.
- A switch or a button often fails to work properly.
- There is a burning smell.
- Water leaks from the indoor unit.

Turn off the circuit breaker and call your dealer.



### ■ After a power failure

- The air conditioner automatically resumes operation in about 3 minutes. Please wait for a while.

### ■ Lightning

- If there is a risk lightning could strike in the neighborhood, stop operation and turn off the circuit breaker to protect the system.

## ■ Disposal requirements

- Dismantling of the unit, handling of the refrigerant, oil and other parts, should be done in accordance with the relevant local and national regulations.

# MEMO



© 2023 **DAIKIN COMFORT TECHNOLOGIES MANUFACTURING, L.P.**

19001 Kermier Road  
Waller, TX 77484  
<https://www.northamerica-daikin.com>



**Intertek**



The two-dimensional bar code is a manufacturing code.

3P741457-2H M23B159C (2409) HT